

 GradeMetrix®



GRADEMETRIX® EXCAVATOR

3D GNSS GRADE CONTROL
AND GUIDANCE SYSTEM

 Hemisphere®

GRADEMETRIX® EXCAVATOR

GradeMetrix® Excavator is packed with industry leading technology. It is easy to use and delivered at an affordable price. The system can easily be installed and calibrated.

From compact excavators to large civil or mining machines, all are covered by the mastless VR500 all-in-one Smart Antenna or VR1000 Dual Antenna solutions.

The GradeMetrix® Excavator system is designed to fit seamlessly into your existing site infrastructure using standard file formats and is compatible with most base station hardware and corrections. GradeMetrix Excavator, like all GradeMetrix solutions, provides a 3-year warranty for all major components.

New and experienced operators can dramatically increase accuracy, efficiency, and dependability with GradeMetrix® Excavator, resulting in significant ROI in your operations immediately.

GRADEMETRIX® KEY FEATURES

- Access to all GNSS satellite constellations; including GPS, GLONASS, BeiDou, Galileo, and QZSS. for maximum accuracy and coverage in difficult environments.
- GNSS receiver supports industry standard RTK formats including RTCM3.x, ROX, CMR, and CMR+
- 2, 2.5D, and 3D operation modes all standard..
- Operators can create trenches, slopes, and pads from within the cab.
- Supports tilt bucket, tiltrotator, and laser receiver as standard.
- Supports swing boom and knuckle boom excavators.
- Supports DTMs or 3D linework.
- Real-time Cut/Fill color maps are supported to show existing progress.
- Map projections and localized coordinate systems for simplified site alignment to existing designs and models.

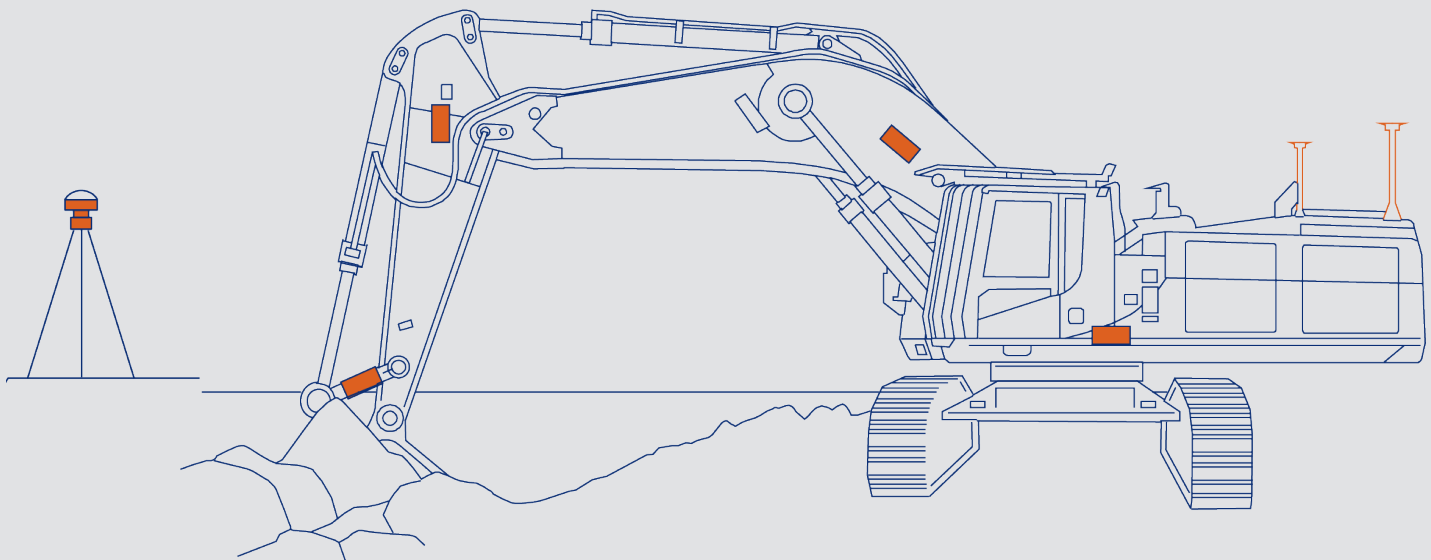

COST SAVINGS – EMBANKMENT OVERCUT

If a batter is overcut by 0.5m over 500m length, the overcut would total 2,500m³. Additional excavator time could be as much as 25 hours and 166 truckloads would be needed at 15m³ per truck. The total cost would be more than the cost of the guidance system.

A GNSS guidance system saves you between 30-50% in material cost, staff cost, and operation cost and improves your production time by the same factor.

Intuitive Menu Design

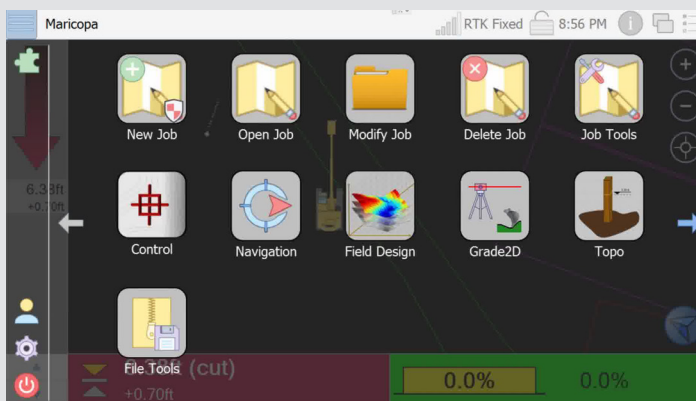

Multiple Views

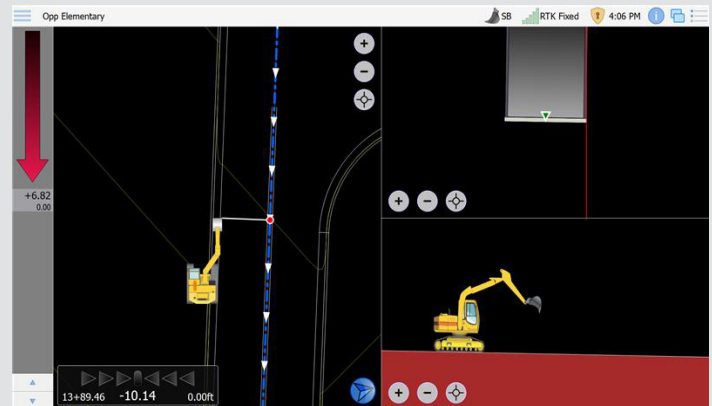

Supports large DTM's

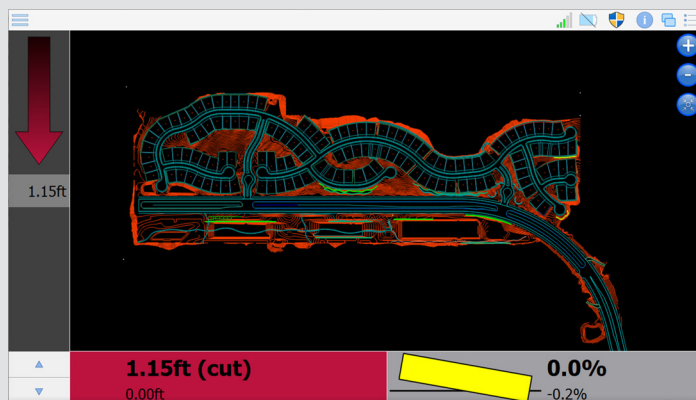

Navigation to a Point

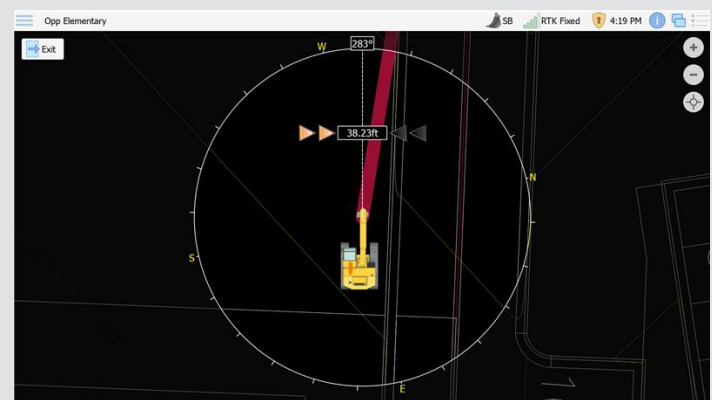

OUR BENEFITS AT A GLANCE

- **RIGHT THE FIRST TIME** – Work Faster – Reduced reliance on operator skill.
- **MATERIAL SAVINGS** – Accurately calculate material volumes – Improve transportation cost – Control soil disposal cost
- **REDUCED SURVEY COST** – Manage site preparation and changes with in field design capabilities. Reduce rework. Eliminate stake replacement
- **IMPROVED SAFETY** – Eliminate grade checking personnel around machines. Reduce operator exits from equipment
- **3-YEAR WARRANTY** – Best In Class Warranty
- **EASILY ADAPTABLE** – Primary components can be moved quickly between machines

2.5D – USE GNSS AT EVERY SITE

The 2.5D function in GradeMetrix® Excavator allows you to use the GNSS Guidance Technology for an array of simple, useful applications without the need for complex 3D files from a model maker.

Using only a few keystrokes, you can easily create simple layers, single or dual slopes, ramps, and even roads: using your GNSS as a reference.

2.5D eliminates the need for survey points, local transformations, and projections, resulting in faster work cycles and dramatically improved ROI.

RUGGEDIZED HARDWARE

GradeMetrix® Excavator solution is hardware components that have passed extensive shock, vibration and environmental testing to withstand the harshest job site conditions.

Grademetrix is designed with support for the VR1000 and VR500 GNSS RTK heading receivers. Both receivers, with their integrated UHF radio, require a single cable connection to the IronTwo display. Multiple decades of experience merging GNSS technology with precision applications provides a simplified installation and calibration procedure.

APPLICATION EXAMPLES

ROAD CONSTRUCTION

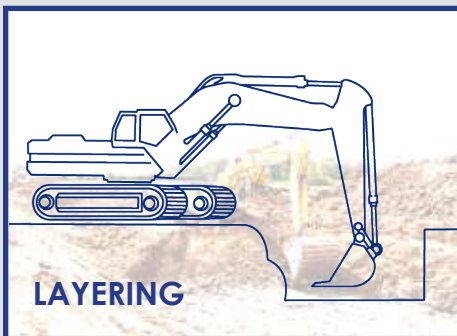

WATER RETENTION BASIN

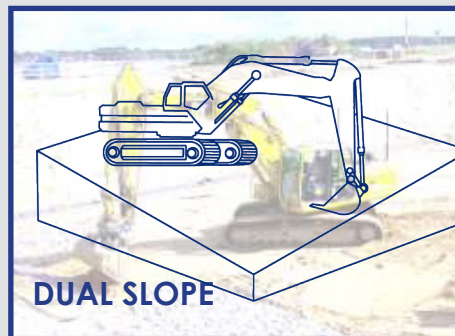

EMBANKMENT WORK

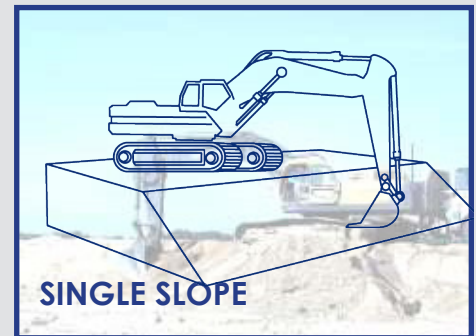

DIKE CONSTRUCTION

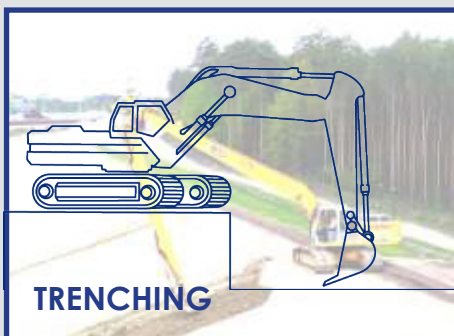

CANAL REDEVELOPMENT

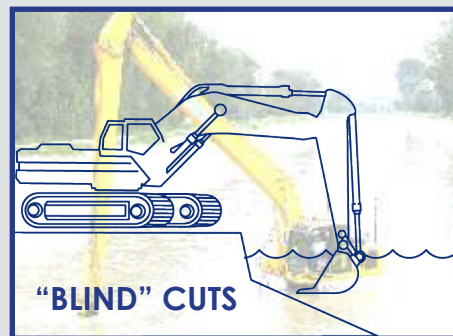



IRON TWO RUGGED DISPLAY

- 10" (1920 x 1200 resolution) touchscreen
- Microsoft Windows™ operating system
- Sunlight Viewable display
- Easy and intuitive user interface
- Handles large 3D DTM project files
- Wi-Fi, Bluetooth, and ethernet support
- Integrated cellular modem for Ntrip corrections or remote/ data support
- IP65 rating



VR500 GNSS RTK SMART ANTENNA

- Mastless position and heading RTK Smart Antenna for compact excavators
- Multi-frequency, Multi-GNSS GPS/GLONASS/BeiDou/Galileo/QZSS capable
- Integrated 400MHz UHF radio
- Powerful WebUI, ethernet, CAN, serial, Bluetooth and Wi-Fi
- IP69K and MIL-STD-810G
- Hemisphere GNSS Athena® RTK engine
- Supports Hemisphere GNSS Atlas® L-band Correction Service



VR1000 GNSS RTK HEADING RECEIVER

- Multi-frequency, Multi-GNSS GPS/GLONASS/BeiDou/Galileo/QZSS capable
- Rugged GNSS Receiver
- IP69K and MIL-STD-810G
- Integrated 400MHz UHF Radio
- Powerful WebUI with ethernet, CAN, serial, Bluetooth and Wi-Fi connections
- Hemisphere GNSS Athena® RTK engine
- Supports Hemisphere GNSS Atlas® L-band Correction Service



A46 GNSS ANTENNA

- IP69K Enclosure /EP455 Shock/Vibration Rating
- Compact Design
- Signals Received: GPS L1/L2/L5, GLONASS G1/G2, BeiDou B1/B2/B3, SBAS, L-band, Galileo E1/E5a/E5b, and QZSS



Hemisphere GNSS

8515 E. Anderson Drive
Scottsdale, AZ 85255, USA

Toll-Free Phone: +1 855 203 1770

Phone: +1 480 348 6380

Fax: +1 480 270 5070

hgns.com
GradeMetrix.com

 **Hemisphere**[®]